

60 DPM-2100 2F

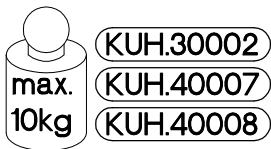

KUH.30002
KUH.40007
KUH.40008

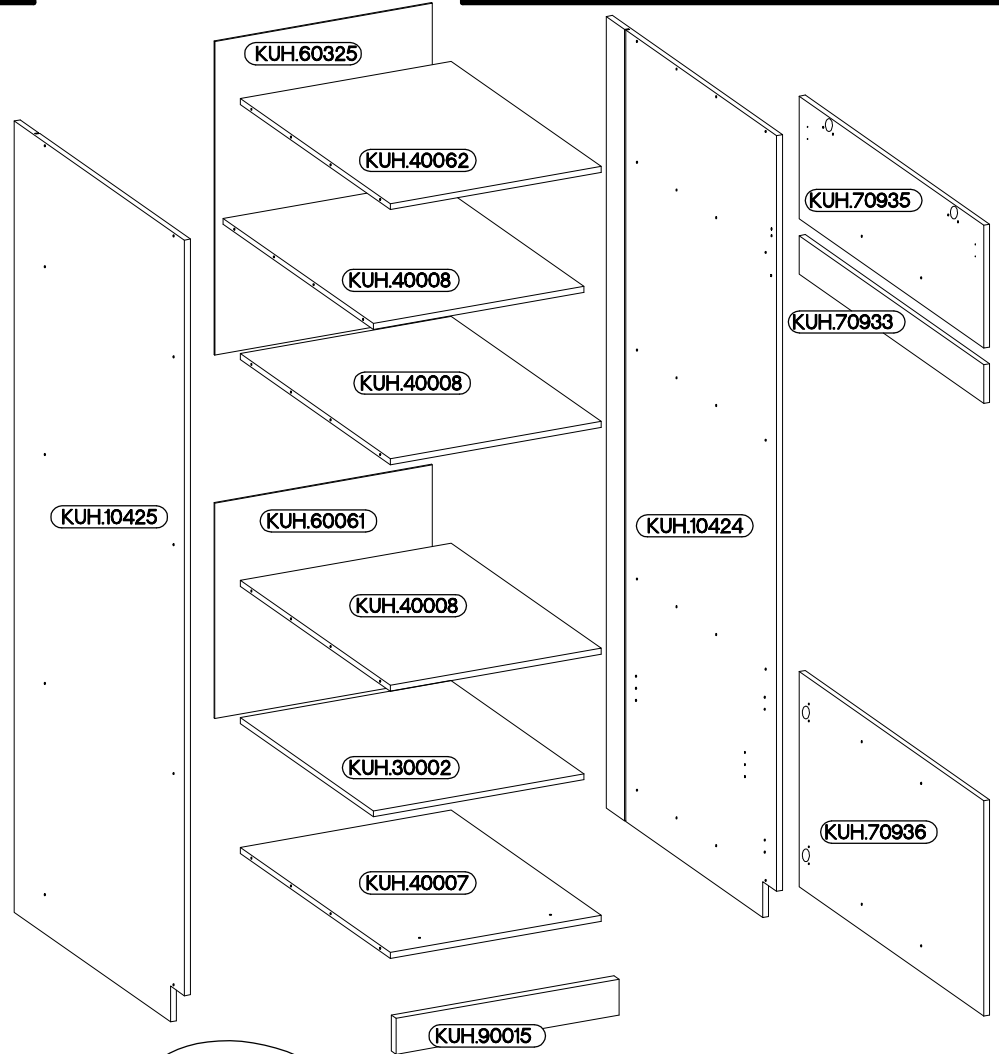

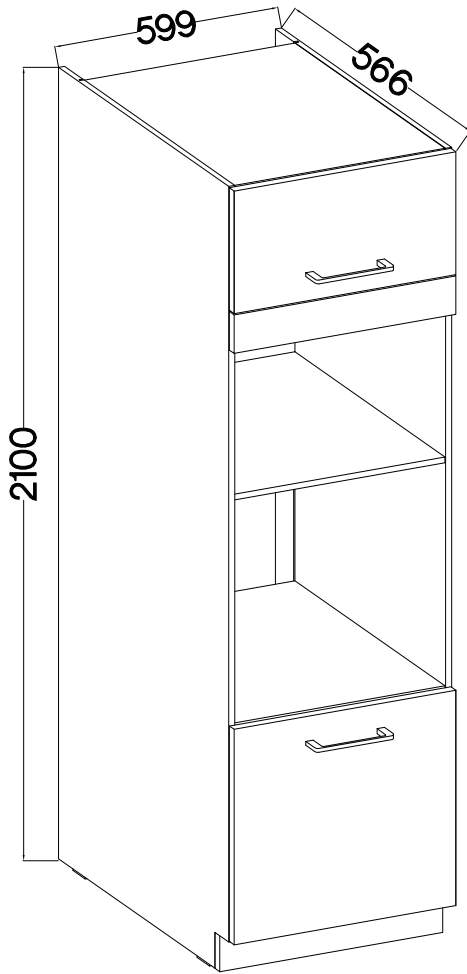
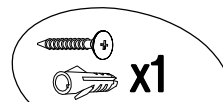

†8x30mm A	6,4 x 50mm B	E1	E9				
20	20	20	2				
6.5x48x16 F2	†35/0mm HG	†5/19mm J	J5	K24		L25	
4	4	4	2	2		1	
O	†4.0x16mm P1	†4.0x45mm P4	†3.5x13mm P5	†3.0x20mm P7	L=192mm S	M4x22mm U	T3
1	4	2	10	15-20	2	4	2

Ersatzteil Nummer	Dimension
KUH.10424	2095x550x16
KUH.10425	2095x550x16
KUH.30002	566x430x16
KUH.40007	567x485x16
KUH.40008 x3	567x485x16
KUH.40062	567x485x16
KUH.60061	570x585x2,5
KUH.60325	830x585x2,5
KUH.70935	596x325x16
KUH.70933	596x102x16
KUH.70936	596x570x16
KUH.90015	599x95x16

ISM-KUH-02169

1

6.5x48x16	+8x30mm
	
F2	A
4	20

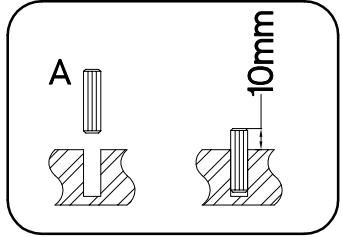
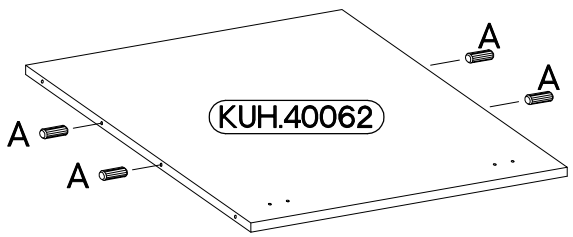
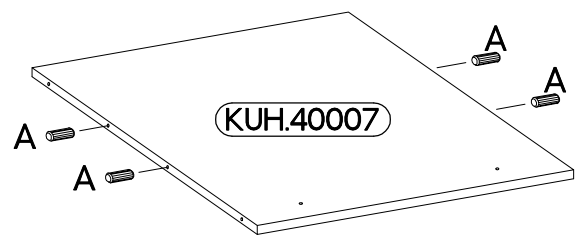
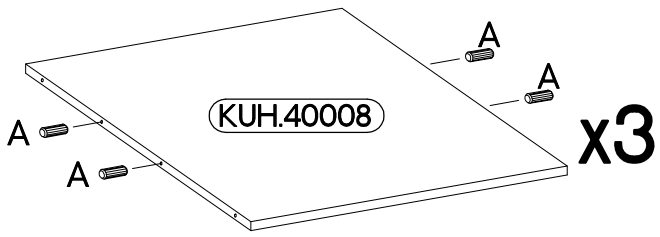
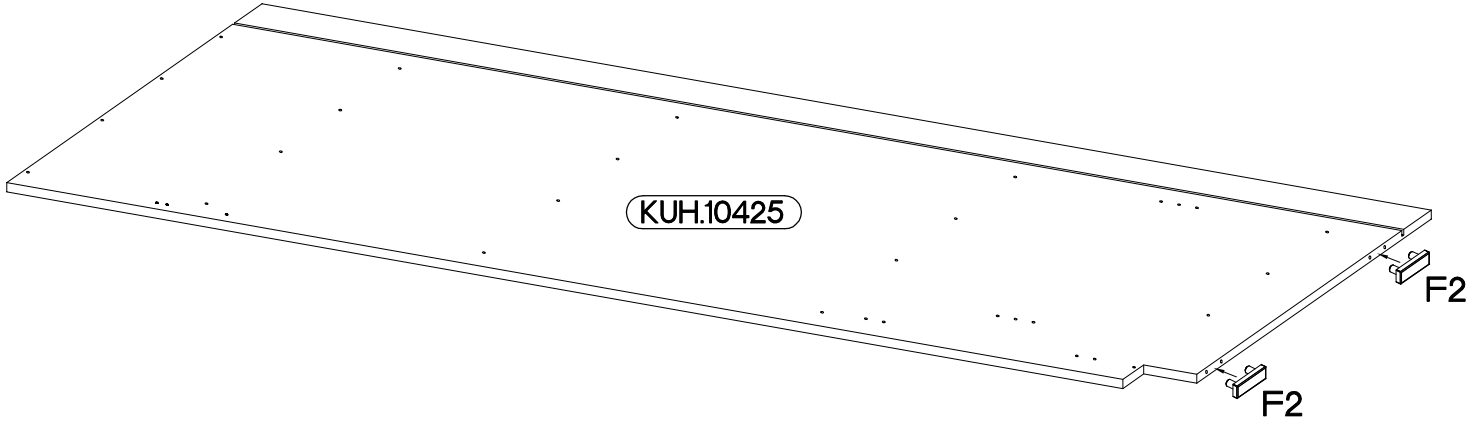
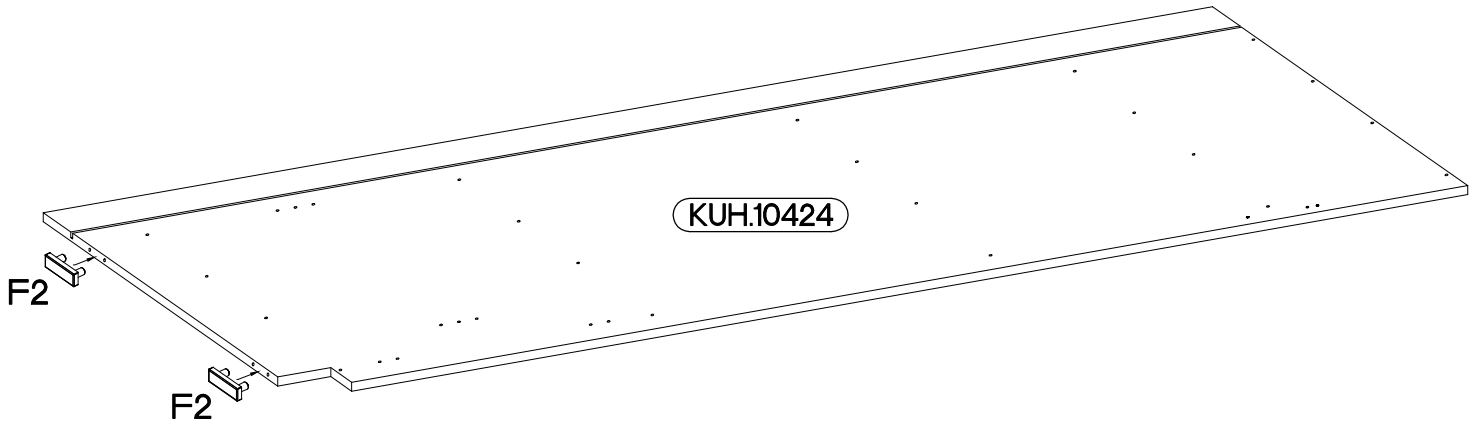
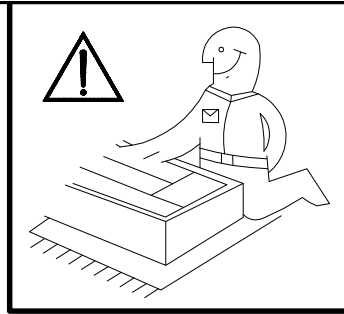
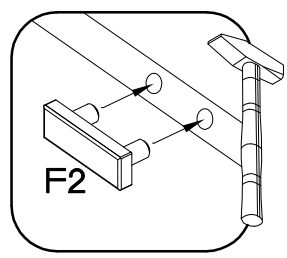

2

6,4 x 50mm

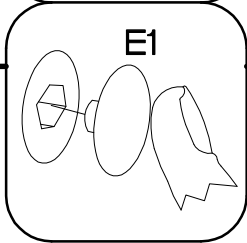
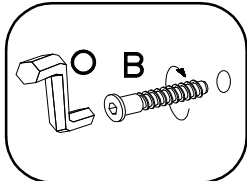
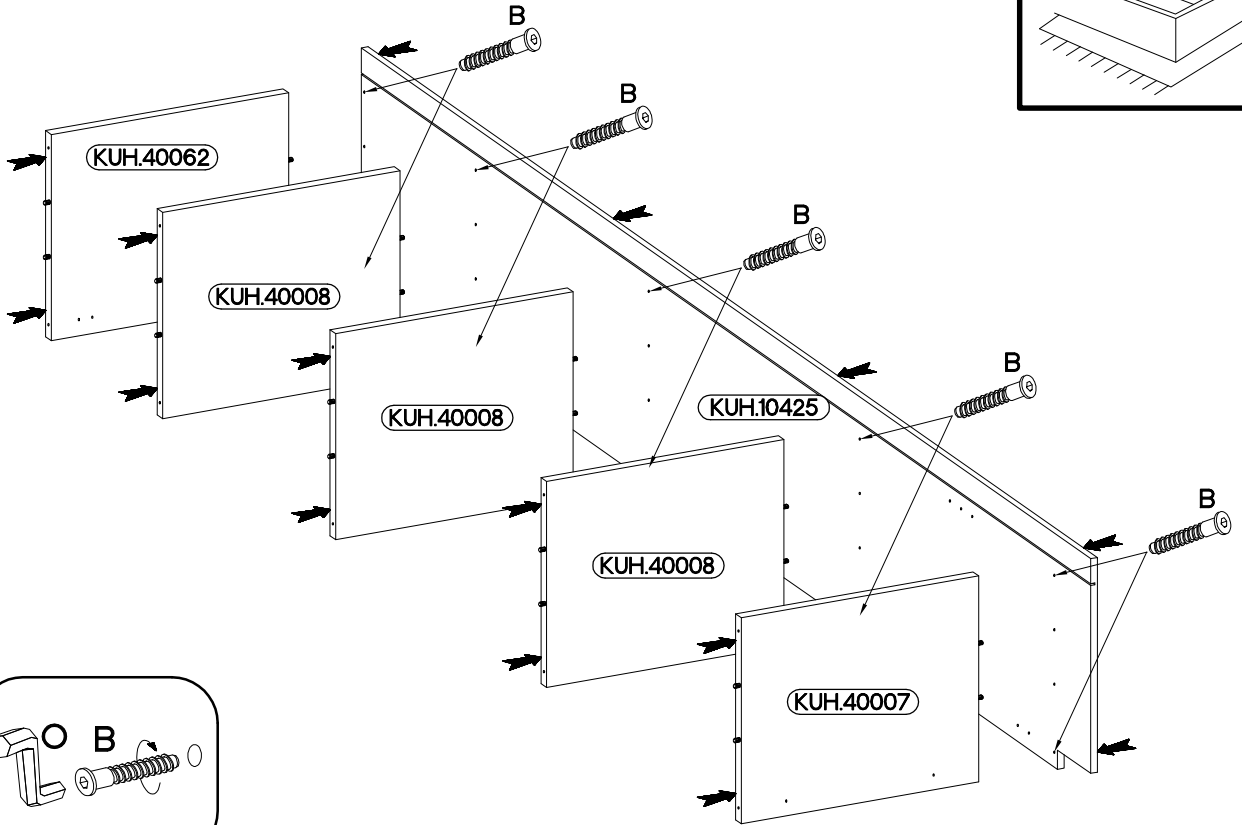
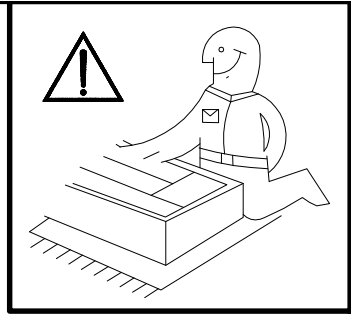
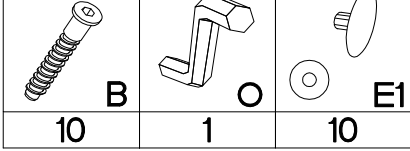

3

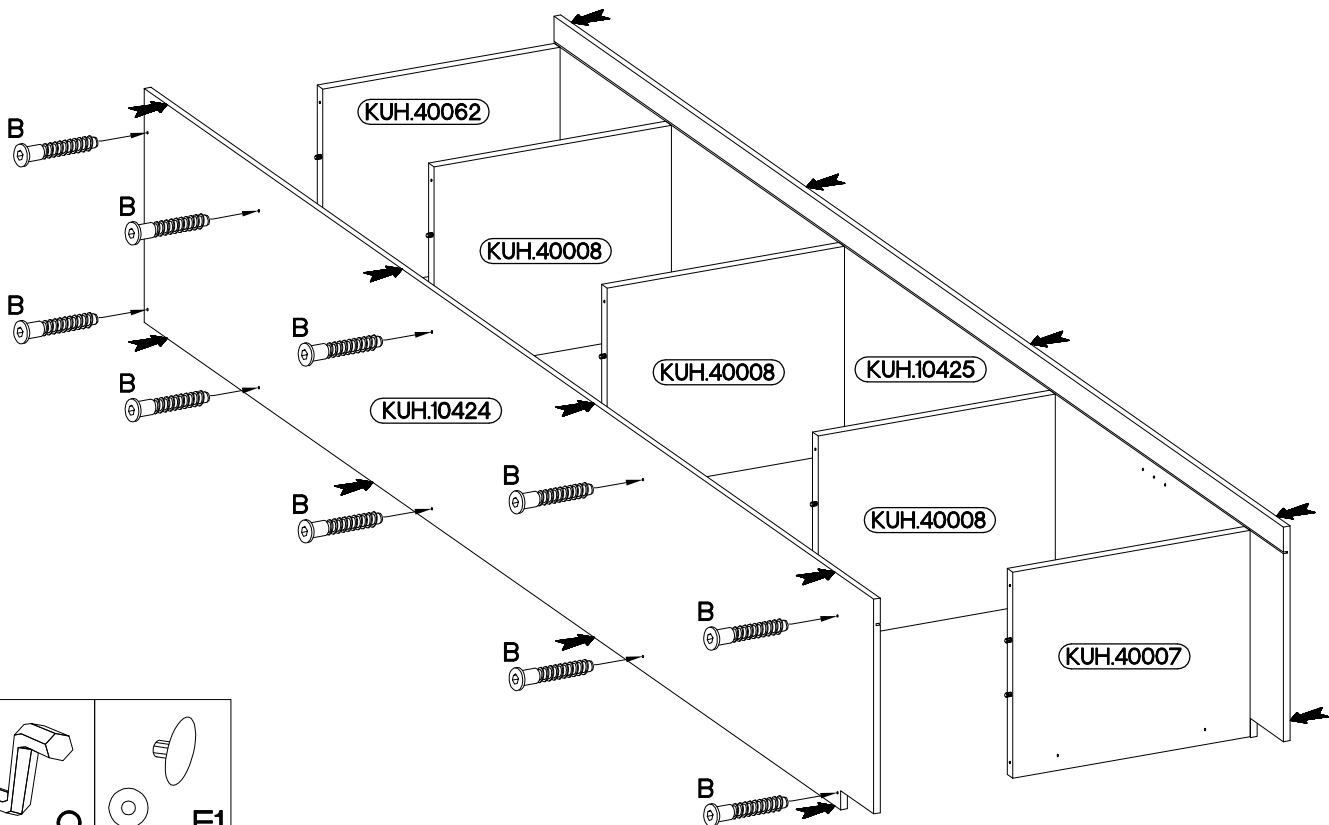

6,4 x 50mm

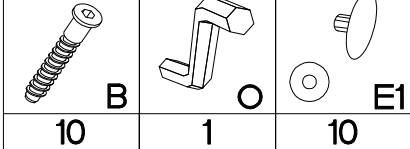

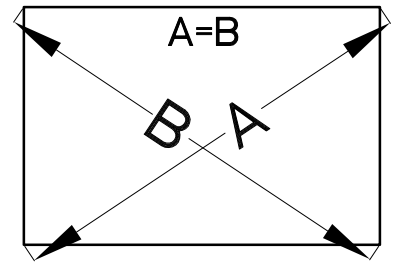
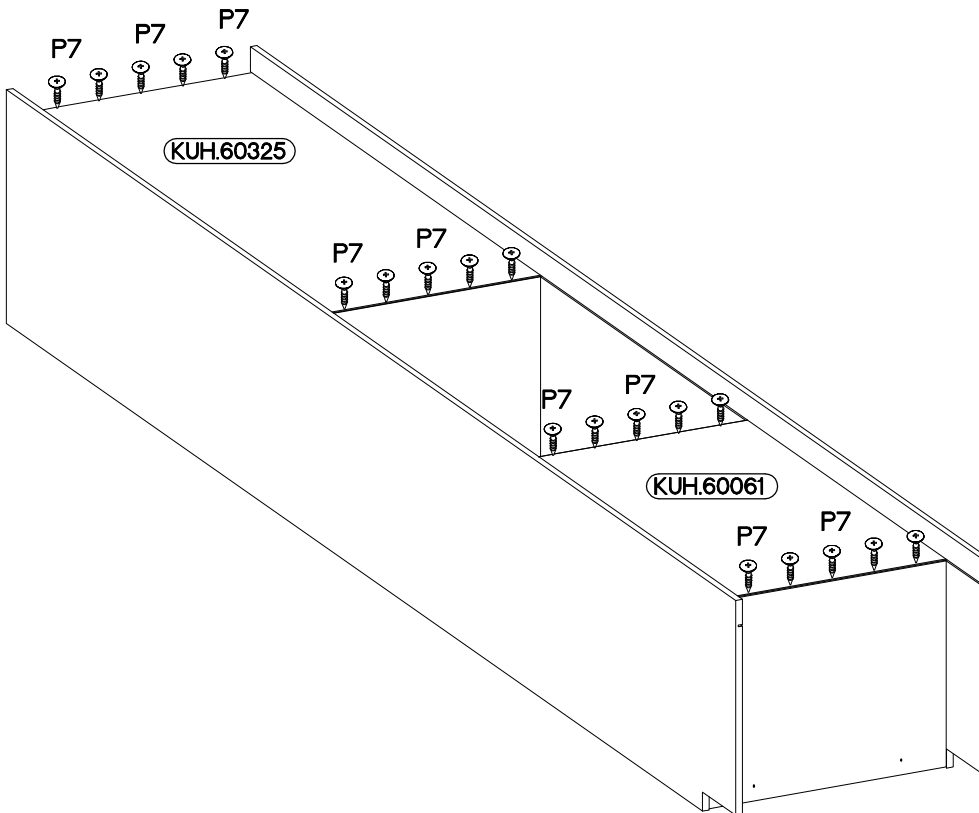
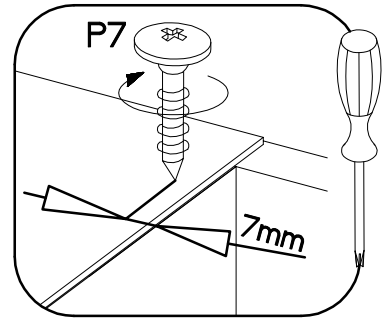
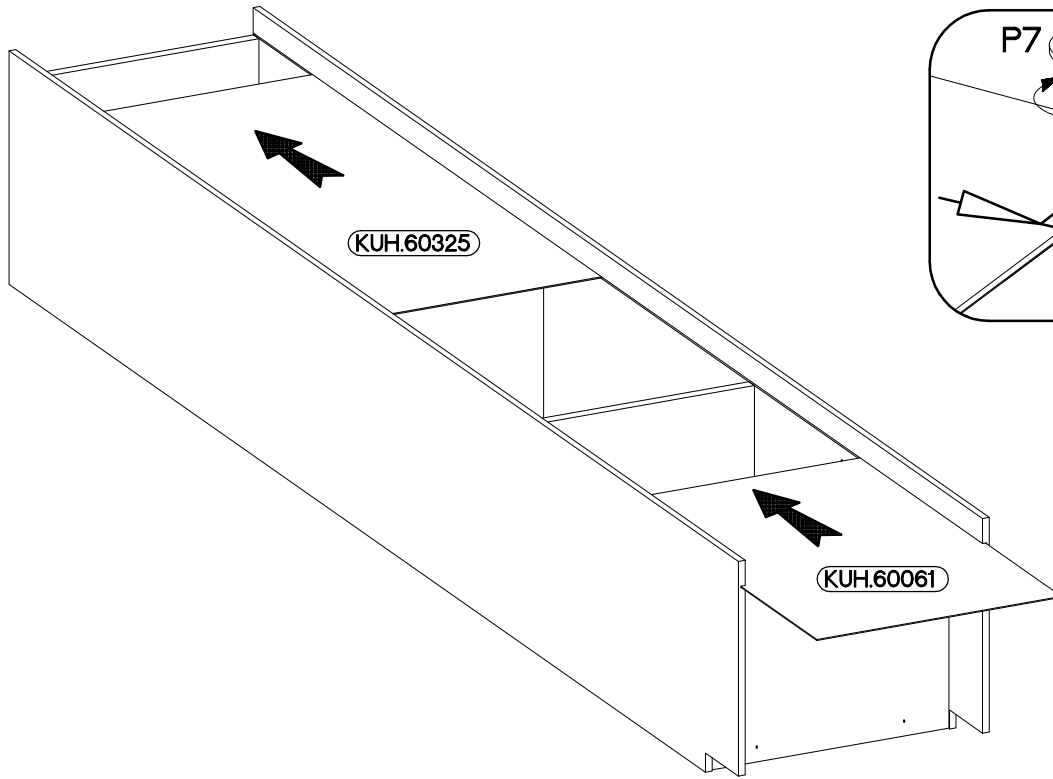
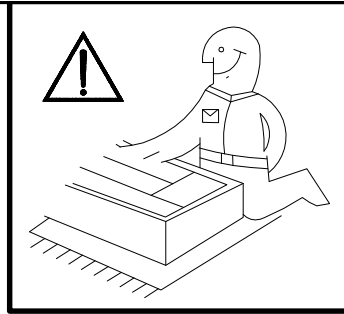

4

±3.0x20mm
P7
15-20



5

$\pm 4.0 \times 45 \text{mm}$  P4 2	 E9 2
--	---

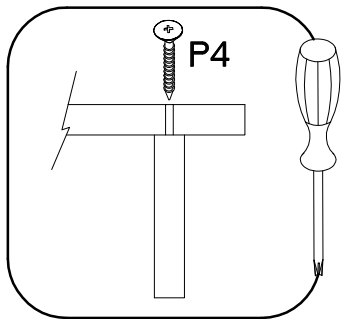
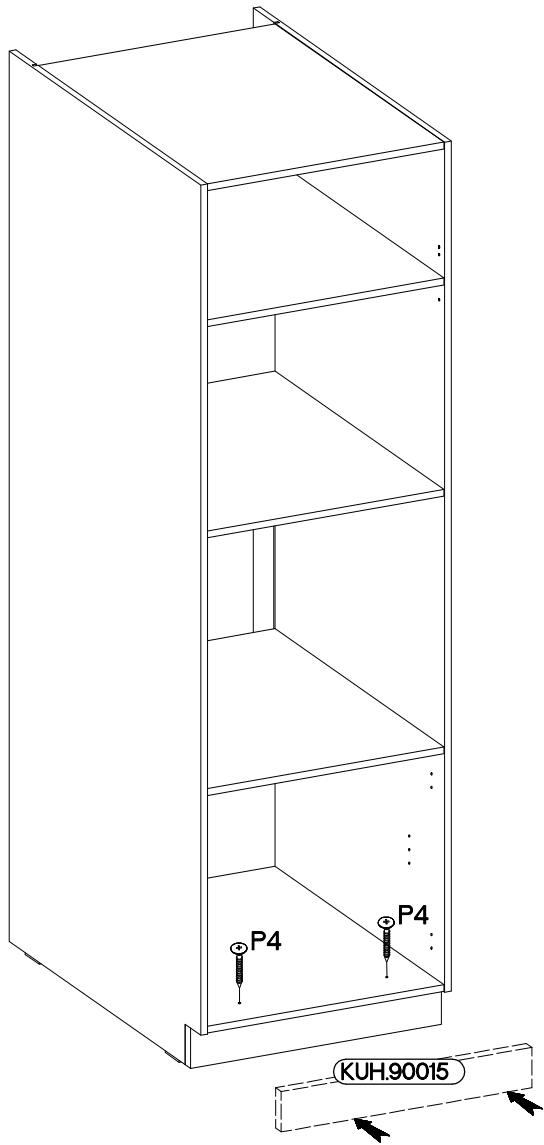

6

$\pm 5/19 \text{mm}$  J 4

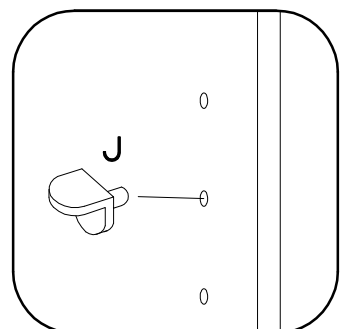
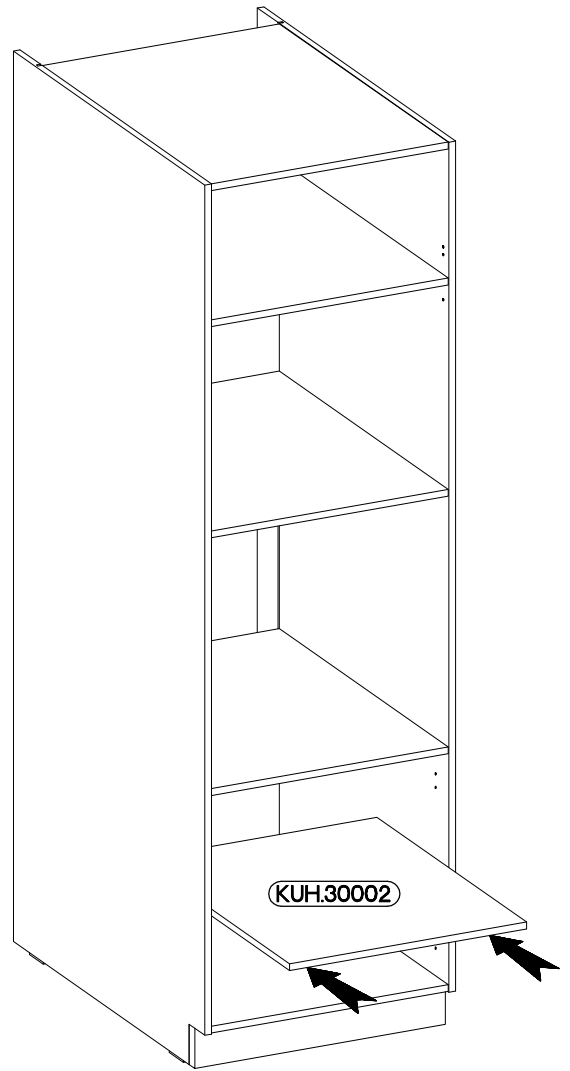

7

120x30x15mm

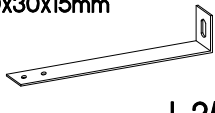

L25

1

+3.5x13mm



P5

2

1.

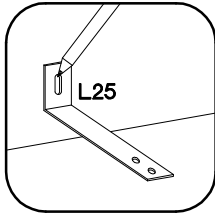

2.

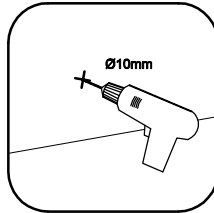

3.

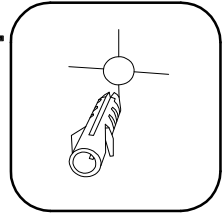

4.

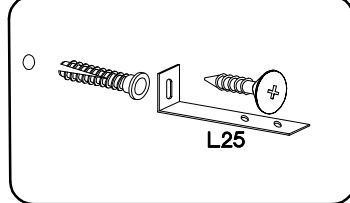

5.

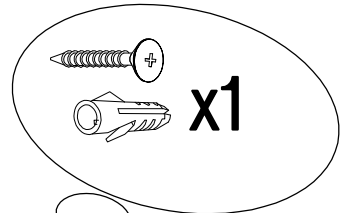
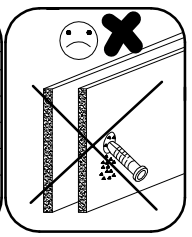
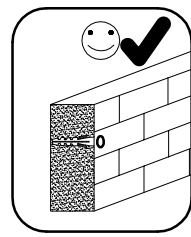
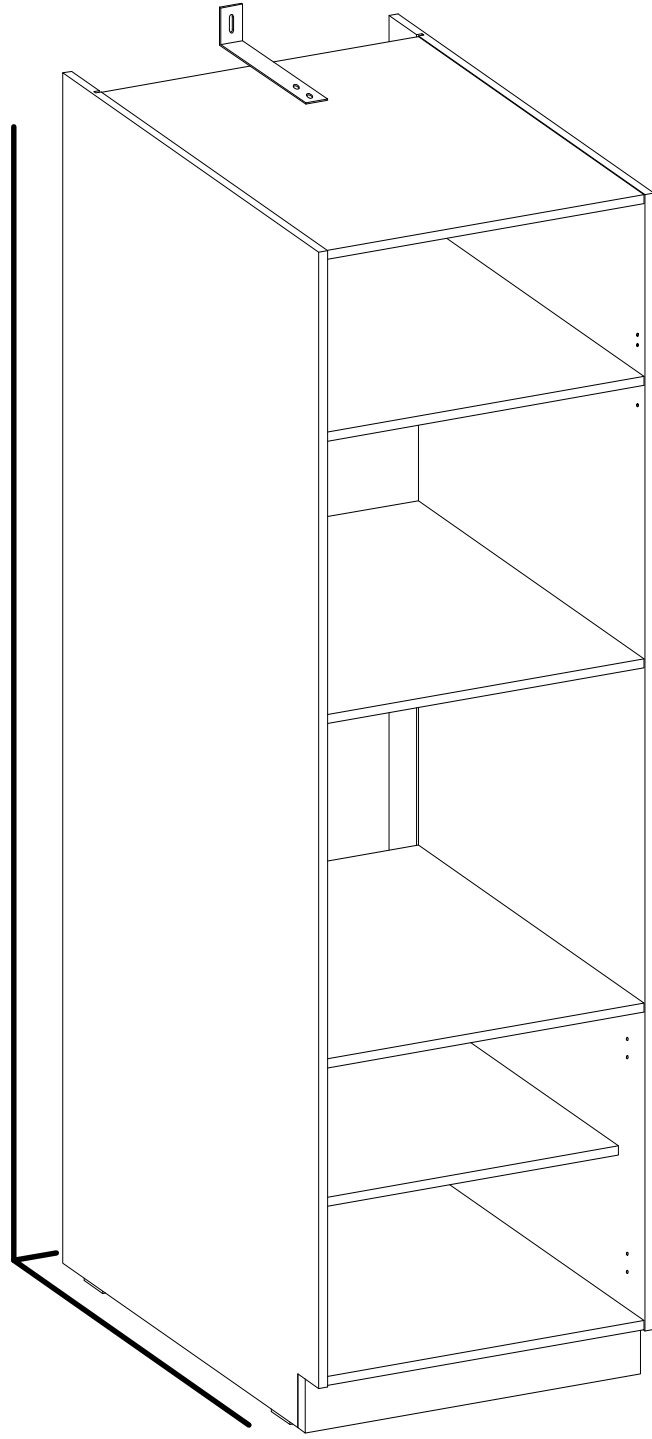
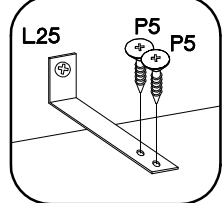

8

LEFT

RIGHT

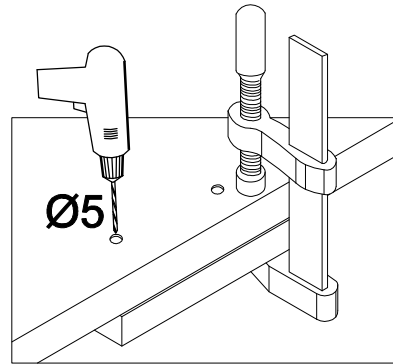
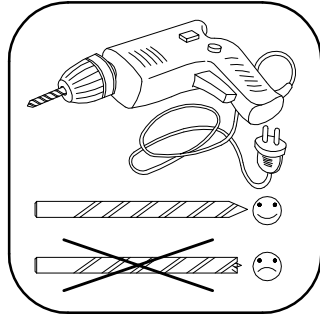
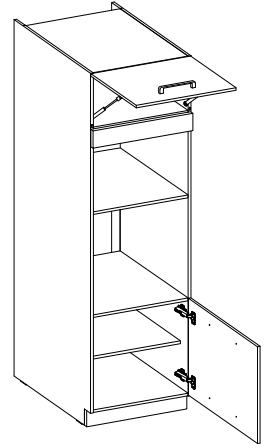
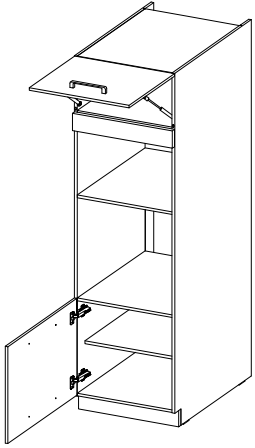
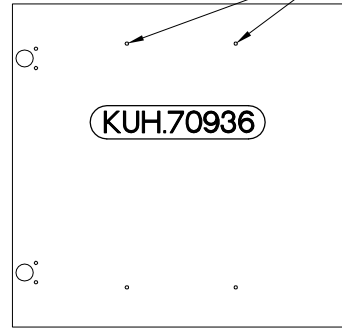
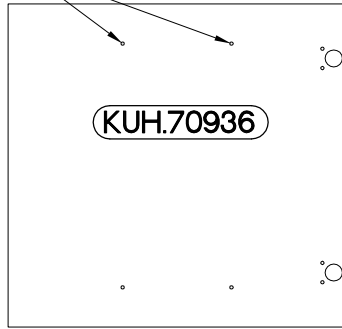
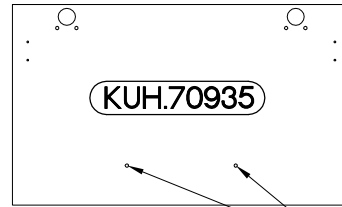
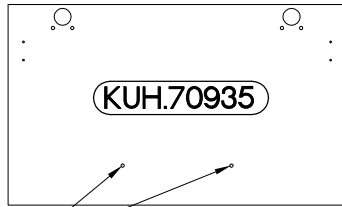
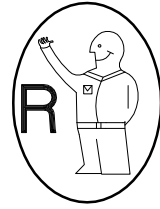
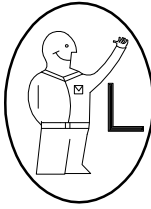



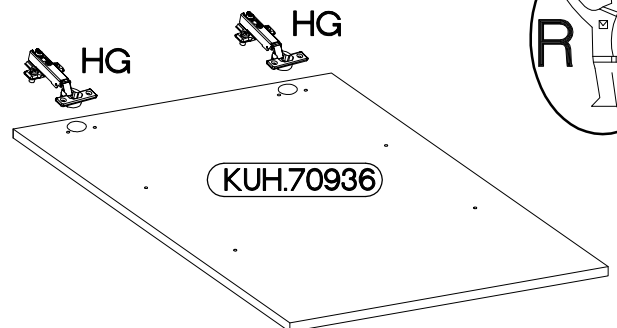
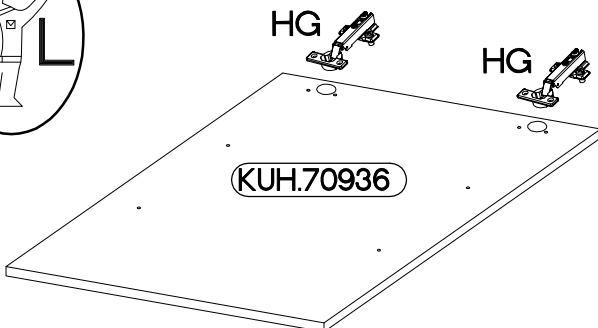
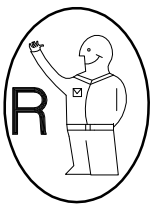
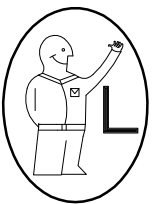
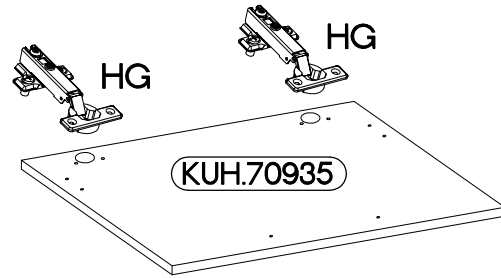
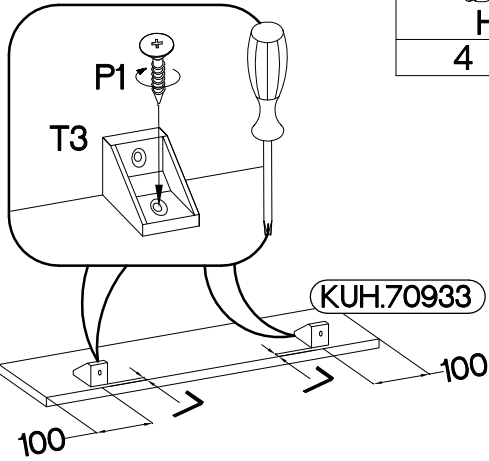
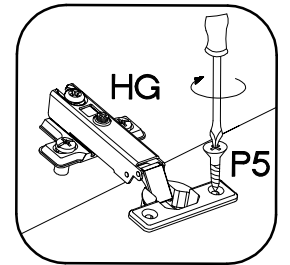

9

 †35/0mm HG 4	 †3.5x13mm P5 8	 T3 2	 †4.0x16mm P1 2
------------------------	--------------------------	-------------	--------------------------

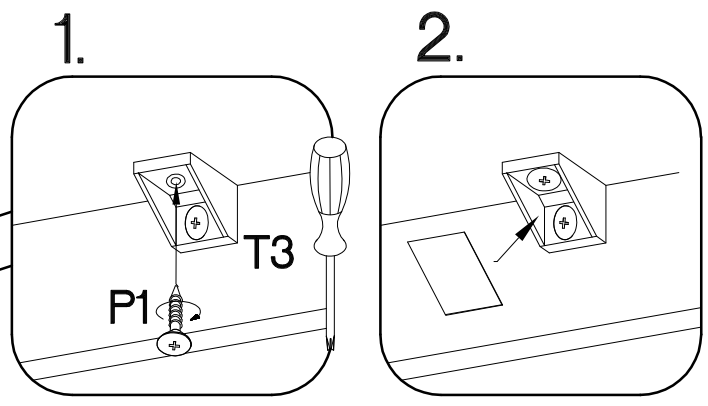
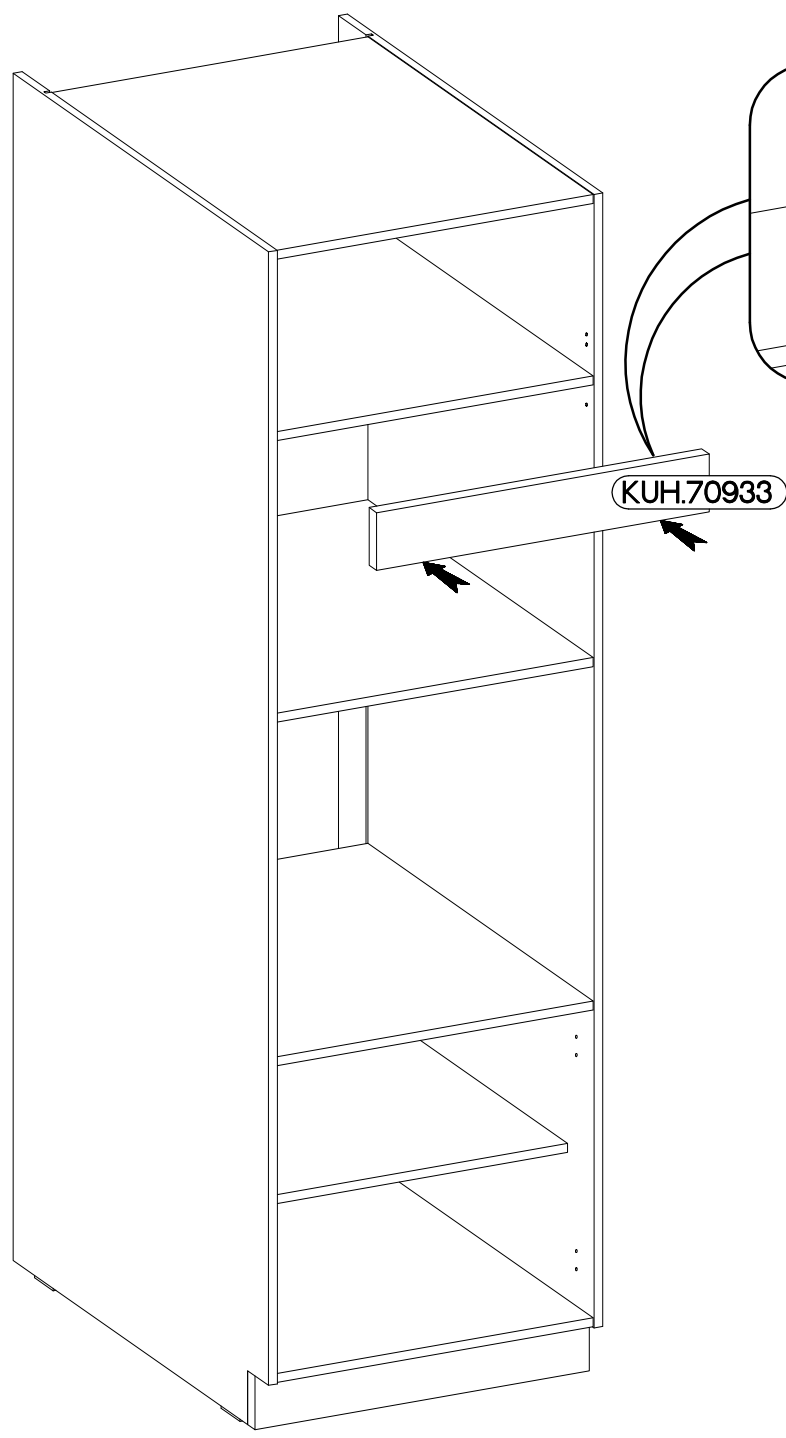

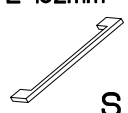
4.0x16mm

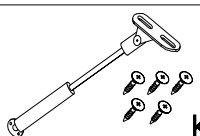
P1
2

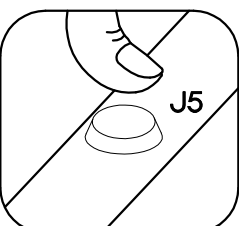
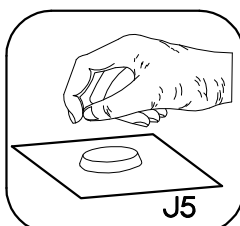
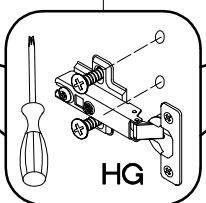
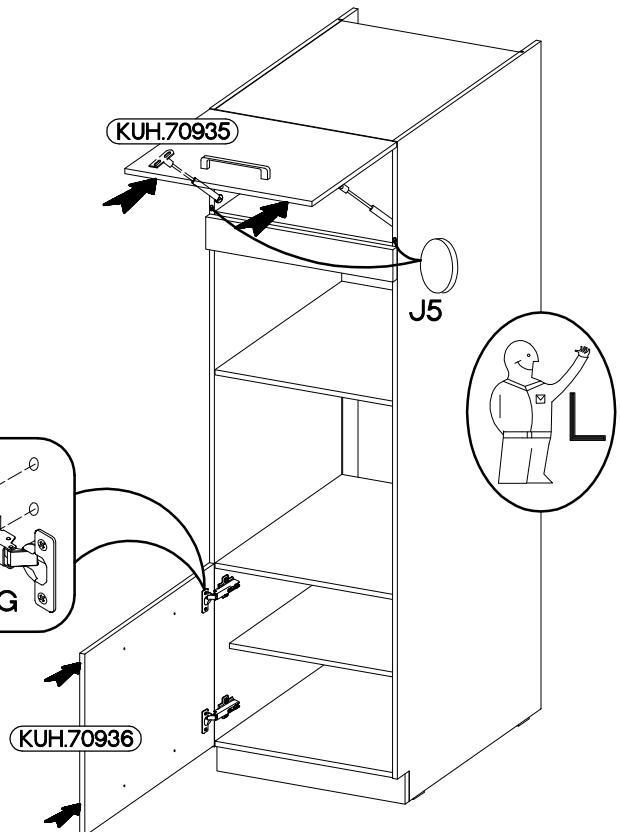
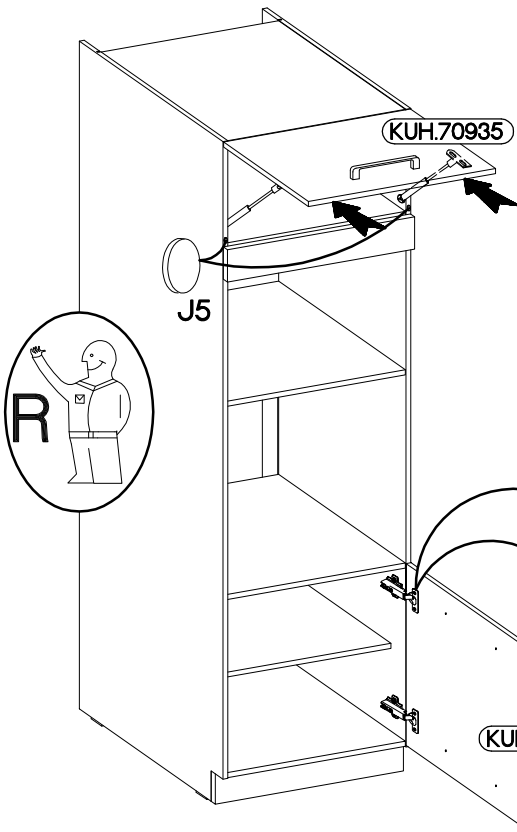
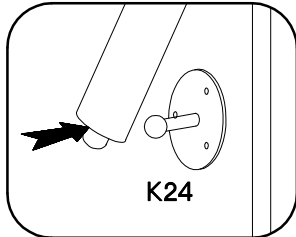
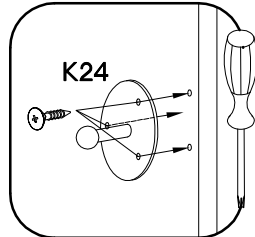
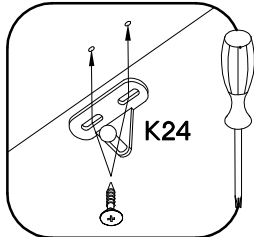
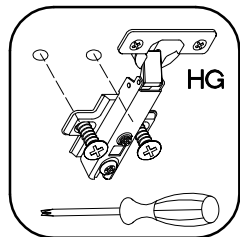
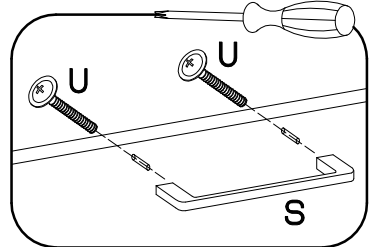

L=192mm	M4x22mm		
			
S	U	K24	J5
2	4	2	2



VARIANT HIGH GLOSS

